

Research Article

Open Access

K. VijayaSekhar, Sanghamitra Debroy, V. Pavan Kumar Miriyala, Swati Ghosh Acharyya, and Amit Acharyya*

Self-healing phenomena of graphene: potential and applications

DOI 10.1515/phys-2016-0040

Received July 14, 2015; accepted February 8, 2016

Abstract: The present study investigates the self healing behavior of both pristine and defected single layer graphene using a molecular dynamic simulation. Single layer graphene containing various defects such as pre-existing vacancies and differently oriented pre-existing cracks were subjected to uniaxial tensile loading till fracture occurred. Once the load was relaxed, the graphene was found to undergo self healing. It was observed that this self healing behaviour of cracks holds irrespective of the nature of pre-existing defects in the graphene sheet. Cracks of any length were found to heal provided the critical crack opening distance lies within 0.3–0.5 nm for a pristine sheet and also for a sheet with pre-existing defects. Detailed bond length analysis of the graphene sheet was done to understand the mechanism of self healing of graphene. The paper also discusses the immense potential of the self healing phenomena of graphene in the field of graphene based sub-nano sensors for crack sensing.

Keywords: Graphene; Sub-nano sensor; crack detection; crack healing; defects; artificial skin

PACS: 81.05.ue

1 Introduction

Graphene, a two-dimensional material system, is the building block of fullerenes, carbon nanotubes and graphite. Since Andre Geim et al. [1] discovered a modest but novel method to isolate single atomic layers

of graphene from graphite in 2004, graphene has attracted significant interest and has become the focus of widespread research due to its unique mechanical, electronic, thermal, and optical properties [1–9]. The exceptional band structure of graphene bestows it with extraordinary electrical transport properties, owing to which it is believed to be an immensely potential candidate for next generation electronics [10–17].

Defects in graphene, especially cracks have been shown to affect both the mechanical and electrical properties of graphene significantly [18]. This has led to numerous studies on understanding the failure behaviour of graphene [19–24]. Understanding the mechanical behaviour of graphene in presence of defects is crucial in the design and key to predicting the ultimate mechanical behaviour of nano-graphene based structural (nano-composites) and nano-electromechanical systems (NEMS).

It has previously been reported both from experimental studies and also by molecular dynamics simulations that graphene can heal its vacancy defects and other topological defects with the aid of metal doping [25–32]. The authors of this paper have reported for the first time that the self-healing phenomena takes place for single layer graphene without any external aid [33]. The authors had shown in their work that cracks nucleated ‘in-situ’ in a graphene sheet due to the application of tensile load self-heals within pico seconds of load relaxation. The phenomenon of self-healing was found to be independent of crack length. However, a critical crack opening displacement range of 0.3–0.5 nm was required for self healing to occur. If the crack opening displacement exceeds this limit no healing was observed to occur.

This paper presents the effects of pre-existing defects on the self-healing phenomenon of cracks in graphene using a molecular dynamics (MD) simulation. With the concept of self-healing of cracks, we envisage a sub-nano sensor design using graphene that can sense cracks as soon as it starts nucleation or even if it had propagated a certain distance the crack then heals making it a potential candidate for next generation electronics applications.

*Corresponding Author: **Amit Acharyya:** Department of Electrical Engineering, Indian Institute of Technology, Hyderabad, India, E-mail: amit_acharyya@iith.ac.in

K. VijayaSekhar, Swati Ghosh Acharyya: School of Engineering Sciences and Technology, University of Hyderabad, India

Sanghamitra Debroy, V. Pavan Kumar Miriyala: Department of Electrical Engineering, Indian Institute of Technology, Hyderabad, India

The remaining paper is organized as follows. Section 2 discusses the simulation methodology, Section 3 represents the phenomena of crack healing, while section 4 discusses the effect of different imperfections on crack healing and section 5 discusses the importance of the critical crack opening displacement. Finally, Section 6 presents the envisaged scenario of sub-nano crack sensing in the presence of different cracks and Section 7 concludes the discussion.

2 Simulation methodology

The MD simulations were performed using LAMMPS [34] (Large-scale Atomic/Molecular Massively parallel simulator). We used AIREBO (Adaptive inter-molecular reactive Bond order potential) to define force fields in our simulation model which originated from the Tersoff-Berner potential. This defines bond-bond interactions, bond breaking, bond reforming, inter molecular interactions between non-bonded atoms, as well as torsion angles formed by the sequence of three bonds [35, 36].

We implemented a quantized fracture mechanics (QFM) modified Griffith's model. Based on QFM modelling, the fracture strength is largely related to crack tip radius and crack length and is accurate in studying the fracture behaviour, previously proved by [37, 38]. The quantised fracture strength is given by the following equation:

$$\sigma_f(l, \rho) = \sigma_c \sqrt{\frac{1 + \rho/2L_0}{1 + 2l/L_0}} \quad (1)$$

where σ_c is fracture strength of pristine sheet, ρ is crack tip radius, l is crack length and L_0 is the minimum propagation distance of the crack.

The simulations were performed on a (5 × 5 nm) graphene sheet which contained 1008 carbon atoms with PBC boundary conditions in two in-plane directions and a vacuum space of 100 nm was considered along the z-direction to avoid edge effects. All simulations were performed at a room temperature by Nose-Hoover thermostat. The velocity-verlet time integrating scheme was applied with a time step of 0.0005 ps and held at equilibrium for 30 ps. After equilibrium was attained, the tensile test had been carried out by deformation control method by applying strain loading with an increment of 0.001/ps until the ultimate tensile strength of the material was reached. In order to study self-healing phenomenon, all the forces acting on the deformed graphene sheet were removed and the sheet was allowed to relax for a period of 150 ps.

3 Tensile testing of graphene sheet & observation of self-healing of cracks

Tensile testing of a graphene sheet (5 × 5 nm) was carried out for pristine condition in longitudinal loading direction. The simulations have been carried out at constant room temperature $T=300$ K, in the canonical ensemble (NVT), where the amount of substance is (N), volume (V) and temperature (T). Periodic Boundary Conditions were imposed on the system and allowed to relax for a period of 30 ps. The cracks were formed and it propagated in the pristine sheets after the load exceeded the ultimate tensile strength during uniaxial loading.

Once all the forces acting on the deformed graphene sheet were removed and the sheet was relaxed, the cracks were found to heal provided the critical crack opening displacement of 0.3–0.5 nm was met. The phenomenon of self-healing of cracks in pristine graphene was earlier reported by the authors [33]. Figure 1(A-D) shows the different stages of self-healing for a pristine sheet in longitudinal mode.

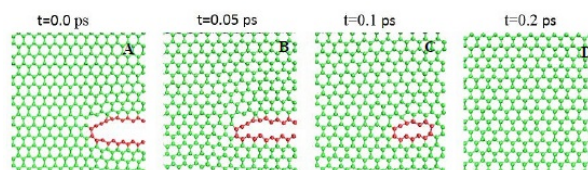

Figure 1: (A-D). Shows the different stages of self-healing for pristine sheet after relaxation for the case of loading in longitudinal mode.

In case of a pristine graphene sheet loaded in a longitudinal direction at relaxation time $t=0$ ps the carbon atoms in the defected region have dangling bonds which were unsaturated and were energetically unstable [39]. If the crack opening length was less than or equal to 0.5 nm the chemical binding energy was found to be negative, ensuring attractive forces were present in between the nearest neighbouring carbon atoms. The detailed calculations based on chemical binding energy has been explained in section V.

At $t = 0$ ps, i.e. at the point of relaxation of the sheet, 91% of the carbon bond lengths were found to be elongated in the range of 1.43–1.78 Å as compared to the bond length of 1.42 Å. At $t = 0.1$ ps, it was observed that the carbon atoms started reconstructing through dangling bond

saturation, forming non-hexagonal rings i.e. pentagon-heptagons (5–7–7–5) structure on the graphene sheet. This pentagon-heptagon rings are known as Stone–Wales construction, which can be seen as the result of a C–C bond rotation by 90° that transforms four hexagons into two pentagons and two heptagons. This type of defect has been investigated previously [40, 41]. In the present study, the Stone–Wales construction acts as a spontaneous topological change for the repair of the defective sheet. The defective graphene started healing, through the formation of Stone–Wales (SW) construction which is energetically preferred in self-healing processes [42] while only 41% bonds remained elongated (1.43–1.48 Å) in the entire sheet at $t=0.1$ ps. Finally at $t=0.2$ ps, it was found that the carbon atom coalesced due to atomic rearrangements leading to healing of the broken bonds. At this point of time 33% of the bonds still remained elongated within a range of 1.43–1.52 Å and the rest (67%) fell into the equilibrium bond length of 1.42 Å.

Therefore at $t=0.2$ ps, self healing of the cracks took place and the resultant sheet was still left with some vacancies and Stone–Wales defects. Terrones et al. [43] had also observed that the presence of Stone–Wales structures can result in coalescence of defective SWCNTs in both armchair and zigzag chiralities leading to self-healing in SWCNT. Figure 2 shows the stages of self-healing through bond length analysis.

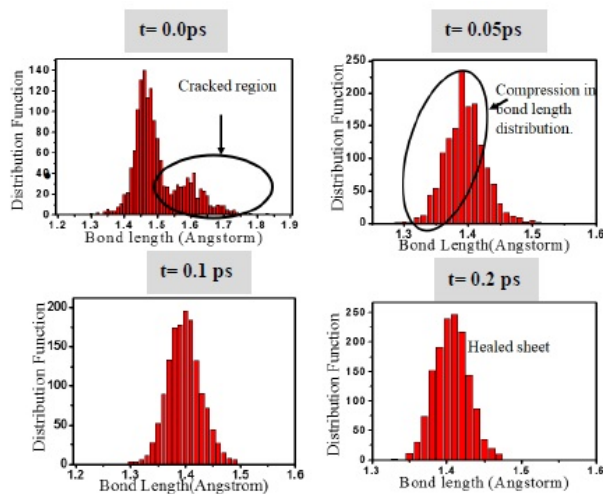

Figure 2: Shows different stages of self healing through bond length analysis.

In order to determine the strength of the healed graphene sheet, tensile testing of the healed graphene sheet was carried out, and the fracture strength observed was about 16% less as compared to the pristine graphene

sheet. The reduction in the value of fracture stress is owing to the formation of Stone–Wales-defect in the healed sheet. This proves that the graphene sheet can be reused repetitively but with certain degradation in the strength of the sheet.

4 Effect of varying defect morphology on crack-healing behavior

Effect of different type of imperfections & defects on the self-healing of cracks were studied with the help of MD simulations. The density of defects were varied by varying the concentration of missing atoms as follows 0.09%, 0.2%, 0.4%, 0.6%, 2% and 5% in the graphene sheet, with pre-existing defects (like single vacancy, multiple vacancies, cracks etc.) in longitudinal as well as transverse mode and were tested in tensile loading. Once the crack formed in-situ and propagated after reaching the ultimate tensile strength, the sheet was relaxed by removing all the forces acting on the sheet. It was observed that in all the cases self-healing was evident though the defects created initially existed as shown in Figure 3. The reason for this was that the atoms initially deleted cannot heal as the simulation box does not contain any extra atom to fill in the defect. It is evident that crack healing takes place (in span of pico seconds) in each case whenever the critical gap between the two separated graphene segments is less than or equals 0.5 nm. Interestingly, it was observed that as the length of the defect increases, e.g. from single to multiple vacancies to cracks, the time to heal the crack also increased.

5 Critical crack opening displacement

In all of the cases discussed above, the study was repeated with different values of crack length and crack opening displacement so as to arrive at the critical crack length and crack opening displacement required for self healing to occur. The results indicated that the phenomenon of self-healing was independent of the length of the crack. Hence cracks of any length would be healed once the load was relaxed and thus defining critical crack length is not needed. However, the MD simulation indicated that the critical crack opening displacement is required to be within 0.3–







Sl. No	Defect type	Different stages of healing			
1.	Single vacancy defect Longitudinal mode (LM)				
2.	Multiple vacancy in LM mode				
3.	Crack of 2 nm in the centre of sheet LM mode				
4.	Pristine sheet Transverse Mode (TM)				
5.	3 horizontal atoms missing from centre of the sheet in TM Mode				
6.	3 Vertical atoms missing from centre of the sheet in TM mode				
7.	Single Vacancy defect TM mode				

Figure 3: Effect of Defects on Self-healing phenomena.

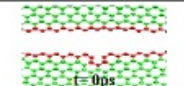
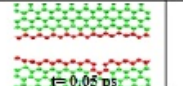
0.5 nm for the cracks to be healed. If the crack opening exceeded 0.5 nm, self healing of the cracks would not take place.

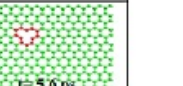
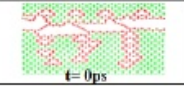
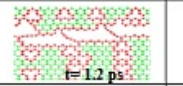
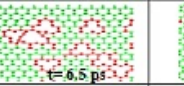
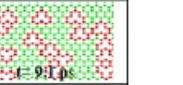
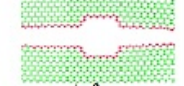
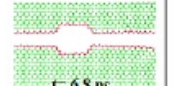
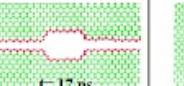
The critical crack opening of ~ 0.5 nm was arrived at from the interatomic interaction forces. Chemical binding energy E_b between the atoms is given by [44]:

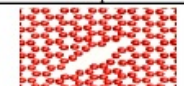
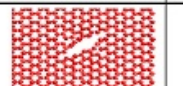
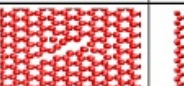
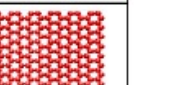
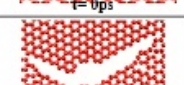
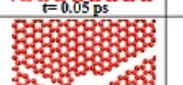
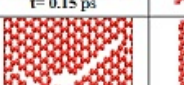
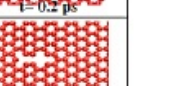
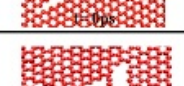
$$E_b = \sum_i \sum_{j>i} [V^R(r_{ij} - b_{ij} V^A(r_{ij}))]. \quad (2)$$

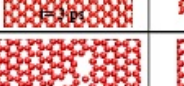
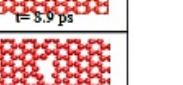
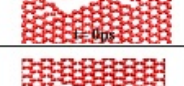
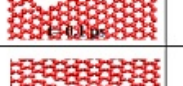
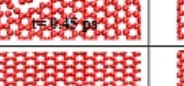
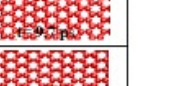
The functions $V^R(r)$ and $V^A(r)$ are pair-additive interactions that represent all interatomic repulsions (core-core) and attraction from valence electrons, respectively. The quantity r_{ij} is the distance between pairs of nearest-neighbour atoms i and j , and b_{ij} is a bond order between atoms i and j that is derivable from Huckel or similar level electronic structure theory. The terms $V^R(r)$ and $V^A(r)$ for carbon-carbon bonds system are defined by [45] as

$$V^R(r) = f^c(r)(1 + Q/r)Ae^{-\alpha r} \quad (3)$$

$$V^A(r) = f^c(r) \sum_{n=1,3} B_n e^{-\beta_n r}. \quad (4)$$

The subscript n refers to the sum in equation (4), and r is the scalar distance between atoms. The function $f^c(r)$

limits the range of the covalent interactions. The parameter fitting for carbon discussed below assumes a value of one for $f^c(r)$ for nearest neighbours and zero for all other interatomic distances. The variables A , Q , α , B_1 , B_2 , B_3 , β_1 , β_2 and β_3 are defined in [45].

Inserting equation (3) and (4) in equation (2) and the variable values from ref [45], the chemical binding energy vs. the interatomic distance plot has been determined as shown alongside Figure 4. From Figure 4, it was observed that after 0.5 nm the binding energy nearly tends to 0.

6 Potential application of self healing phenomena of graphene

With the unique property of self healing in graphene, we have envisaged an idea of a sub-nano sensor design using graphene that can sense crack as soon as it starts nucleation or even if it had propagated a certain distance and then healing of the crack making it a potential candidate for next generation electronics. The working process of the sensor is applicable only for graphene sheet loaded in longitudinal direction. The reason for this is that in a sensor

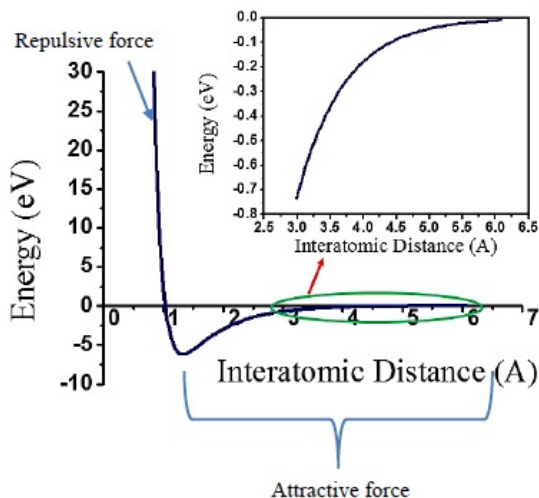

Figure 4: Plot shows the attractive and repulsive pair terms as a function of interatomic distance indicating the importance of critical crack opening displacement.

application, we need the sheet to tear totally in order to have an open circuit. From Figure 3 we observe that for pristine and defective sheet in transverse mode, the sheets do not tear apart totally with uniaxial loading, though self-healing can be observed.

As illustrated in Figure 5a, a voltage source is connected to the graphene sheet. This voltage source generates current passing through the graphene sheet which is loaded in the horizontal direction. Cracks were generated in the graphene sheet by application of a tensile loading up to its ultimate tensile strength at room temperature. The recent research of Yu et al. found that transferred graphene on PDMS grown by CVD has a higher gauge factor of 151 [46]. This shows that there will be change in resistivity of the graphene with a change in mechanical strain. When there is no crack, voltage output will be nearly equal to the input voltage because it acts like closed loop circuitry. As the strain increases, though the resistivity of graphene increases [47], some output voltage can be still obtained. But as the propagating crack leads to a total tear of a sheet the voltage output will equal to 0, and the open circuit will be obtained as shown in Figure 5b. An installed microcontroller shall receive the zero voltage signal and act simultaneously to send the signal so as to release the load or stop further mechanical stretching or bending activity. Instantaneously, the graphene sheet will heal back again (if crack opening displacement is less than 0.5 nm) and the sensor becomes ready to measure any further surge in deforming load.

As discussed in the previous section, when the critical crack opening displacement is less than 0.3–0.5 nm,

graphene tends to heal its crack by itself. Hence even if a crack nucleates it can be tracked as well as healed. Figure 5 represents the self-healing phenomenon in graphene leading to crack curing. This will allow to sense current same as input due to healing, if the loadings are removed from the system. Healing occurs at a very fast rate of approximately 0.2 ps within the critical range of 0.3–0.5 nm as shown in Figure 6. Even a crack opening displacement above 0.5 nm can be detected but healing in the process cannot be achieved leading to an open circuit as shown in Figure 7. Hence if the microcontroller can send the signal for release of the deforming load or pressure, crack opening displacement can be controlled & thus the graphene sheet can be healed, ensuring perennial use of the sensor. This technology can be extended to various other critical equipment like relief valves in pressure vessels, boilers, cranes etc.

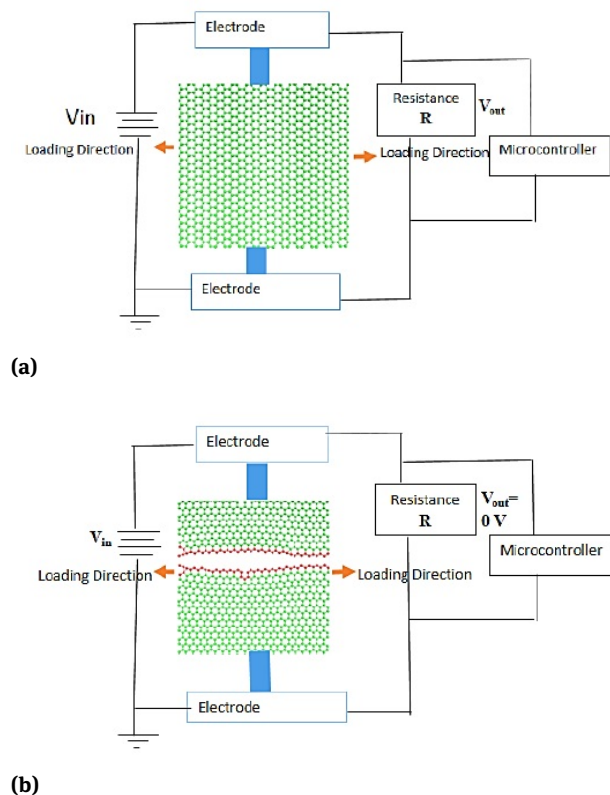

Figure 5: Schematic view of nano graphene sensor- (A) Without crack, (B) With Crack.

It is also evident that crack healing takes place irrespective of the original defect nature in the sheet. Thus, sub-nano sensing may be demonstrated equally efficiently with a pristine or defective parent graphene sheet loaded in a longitudinal direction.

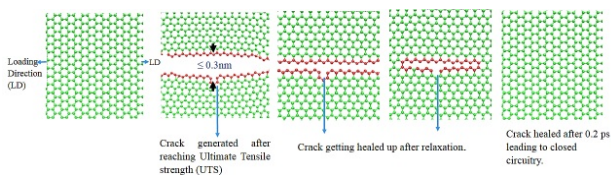

Figure 6: Graphene sheet loaded leading to detection of crack as well healing of crack. Sub-nano sensing of the crack by applying voltage and measuring the output current.

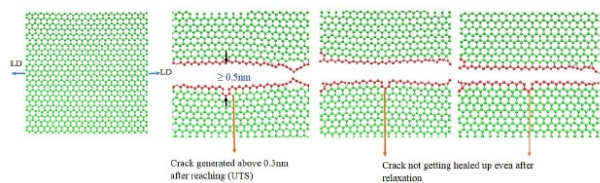

Figure 7: Graphene sheet loaded leading to detection of crack but voltage output is 0 V.

These findings are believed to be significant in the field of next-generation electronics e.g. artificial skin. The skin is the largest organ in the human body. It is mechanically self-healing, but if such behavior can be developed in artificial skin, then it shall prove to be the future for robots used by humans in daily life for numerous applications [48–50]. Due to unprecedented stretching or bending, rupture of this electronic artificial skin can occur in robots. Using the above concept sub-nano crack sensing methodology for graphene based artificial skin could be one of the potential electronic applications in near future.

7 Conclusions

The self healing nature of single layer graphene has been studied both in case of pristine and in the presence of pre-existing defects like vacancies (single and multiple) and cracks of different orientation. The results obtained are summarised as follows:

a) Self healing phenomena of graphene was observed irrespective of the nature of defects pre-existing in the sheet though the time to self-heal increased with increasing defect density.

b) MD simulations showed that cracks underwent self-healing within pico-seconds of load relaxation when the distance between crack surfaces was ≤ 0.5 nm both in presence and in absence of a pre-existing defect.

c) A potential application of the self healing phenomena of graphene has been proposed for artificial skin in future robots etc. which makes graphene a next generation's electronic sensor for sub nano sensing applications.

d) The timescales for the working of the sensor at present is in picoseconds and future research efforts would aim at achieving increased timescale for the realistic implementation of this sensor.

Acknowledgment: The authors would like to acknowledge the following for supporting this work: The School of Engineering Science and Technology University of Hyderabad, India and Indian Institute of Technology (IIT) Hyderabad, India. Department of Science and Technology (DST), Government of India for Innovation in Science Pursuit for Inspired Research (INSPIRE) PhD fellowship to Sanghamitra Debroy (Grant: IF131049); University Grants Commission (UGC), Government of India, Rajiv Gandhi National Fellowship (grant RGNF201517SCAND26105) PhD fellowship to K. Vijaya Sekhar, and Department of Electronics and Information Technology (DEITY), Government of India under Internet Of Things (IOT) for Smarter Healthcare under Grant No: 13(7)/2012-CC&BT, Dated 25th February, 2013.

References

- [1] Geim A.K., Graphene: status and prospects, *Science.*, 2009, 324, 1530–1534.
- [2] Geim A.K and Novoselov K.S., The rise of graphene, *Nature Mater.*, 2007, 6, 183–191.
- [3] Novoselov K.S., Geim A.K., Morozov S.V., Jiang D., Katsnelson M. I., Grigorieva I.V., Dubonos S.V., and Firsov A.A., Two-dimensional gas of massless Dirac fermions in graphene, *Nature.*, 2005, 438, 197–200.
- [4] Morozov S.V., Novoselov K.S., Katsnelson M.I., Schedin F., Elias D.C., Jaszczak J.A., and Geim A.K., Giant intrinsic carrier mobilities in graphene and its bilayer, *Phys. Rev. Lett.*, 2008, 100, 016602.
- [5] Kürüm U., Ekiz O. Ö., Yaglioglu H. G., Elmali A., Ürel M., Güner H., Mızrak A. K., Ortac B., and Dâna A., Electrochemically tunable ultrafast optical response of graphene oxide, *Appl. Phys. Lett.*, 2011, 98, 141103.
- [6] Liu J., Wright A. R., Zhang C., and Ma Z., Strong terahertz conductance of graphene nanoribbons under a magnetic field, *Appl. Phys. Lett.*, 2008, 93, 041106.
- [7] Saito K., Nakamura J., and Natori A., Ballistic thermal conductance of a graphene sheet, *Phys. Rev. B.*, 2007, 76, 115409.
- [8] Balandin A. A., Ghosh S., Bao W., Calizo I., Teweldebrhan D., Miao F., and Lau C. N., Superior thermal conductor graphene, *Nano Lett.*, 2008, 8, 902–907.
- [9] Frank I. W., Tanenbaum D. M., van der Zande A. M., and McEuen P. L., Mechanical property of suspended graphene sheets, *J. Vac. Sci. Technol. B.*, 2007, 25, 2558.
- [10] Bolotin K. I., Sikes K. J., Hone J., Stormer H. L., & Kim P., Temperature-Dependent Transport in Suspended Graphene, *Phys. Rev. Lett.*, 2008, 101, 096802.

- [11] Chenguang L., Zhenning Y., David N., Aruna Z., & Bor J., Graphene-Based Supercapacitor with an Ultrahigh Energy Density, *Nano Lett.*, 2010, 10, 4863–4868.
- [12] Castro Neto A. H., Guinea F., Peres N. M. R., Novoselov K. S., and Geim A. K., The electronic properties of graphene, *Rev. Mod. Phys.*, 2009, 81, 109.
- [13] Qiong W., Yuxi X., Zhiyi Y., Anran L., & Gaoquan S., Super capacitors Based on Flexible Graphene/ Polyaniline Nanofiber Composite Films, *NanoLett.*, 2010, 4, 1963–1970.
- [14] Lin Y.M., Jenkins K.A., Valdes-Garcia A., Small J.P., Farmer D.B., and Avouris P., Operation of Graphene Transistors at Gigahertz Frequencies, *Nano Lett.*, 2009, 9, 422–426.
- [15] Liao L., Lin2 Y.C., Bao M., Cheng R., Bai J., Liu Y., Qu Y., Wang K.L., Huang Yu., & Duan X., High-speed graphene transistors with a self-aligned nanowire gate, *Nature*, 2010, 467, 305–308.
- [16] Roman S., Floriano T., & Valeria R. L., Logic gates with a single graphene transistor, *Appl. Phys. Lett.*, 2009, 94, 073305.
- [17] Kang J. W., & Lee K. W., Molecular dynamics study of carbon-nanotube shuttle-memory on graphene nanoribbon array, *Computational Material science*, 2014, 93, 164-168.
- [18] Gorjizadeh N., Farajian A., & Kawazoe Y., The effects of defects on the conductance of graphene nanoribbons, *Nanotechnology*, 2009, 20, 015201.
- [19] Zhao H., & Aluru N. R., Temperature and strain-rate dependent fracture strength of graphene, *J. Appl. Phys.*, 2010, 108, 064321.
- [20] Le M. Q., Batra R. C., Crack propagation in pre-strained single layer graphene sheets, *Computational Materials Science*, 2014, 84, 238–243.
- [21] Le M. Q., Batra R. C., Single-edge crack growth in graphene sheets under tension. *Computational Materials Science*, 2013, 69, 381–388.
- [22] Theodosiou T. C., Saravanos D. A., Numerical simulation of graphene fracture using molecular mechanics based nonlinear finite elements, *Computational Materials Science*, 2014, 82, 56–65.
- [23] Zhang Y. Y., Gu Y. T., Mechanical properties of graphene: Effects of layer number, temperature and isotope. *Computational Materials Science*, 2013, 71, 197–200.
- [24] Peng Z., Lulu M., Feifei F., Zhi Z., Cheng P., et al., Fracture toughness of graphene, *Nat. Communications*, 2014, 5, 3782.
- [25] Zan R., Ramasse Q. M., Bangert U., & Novoselov K. S., Graphene Reknits Its Holes, *Nano Lett.*, 2012, 12, 3936–3940.
- [26] Tsetseris L., & Pantelides S. T., Adatom complexes and self-healing mechanisms on graphene and single-wall carbon nanotubes, *Carbon*, 2008, 47, 901-908.
- [27] Özçelik V. O., Gurel H. H., & Ciraci S., Self-healing of vacancy defects in single-layer graphene and silicene, *Phys. Rev. B*, 2013, 88, 045440.
- [28] Yung- Chang L., Chao- Hui Y., Ju-Chun H., & Po- Wen C., High Mobility Flexible Graphene Field-Effect Transistors with Self-Healing Gate Dielectrics, *NanoLett.*, 2012, 6, 4469–4474.
- [29] Chen J., Shi T., Cai T., Xu T., Sun L., et al., Self healing of defected graphene, *Appl. Phys. Lett.*, 2013, 102, 103107.
- [30] Kim D. Y., Sinha-Ray S., Park J.J., Lee J.G., Cha Y.H., et al., Self-Healing Reduced Graphene Oxide Films by Supersonic Kinetic Spraying, *Adv. Funct. Mater.*, 2014, 24, 4986-4995.
- [31] Xingcheng X., Tao X., & Yang-Tse C., Self-healable graphene polymer composites, *J. Mater. Chem.*, 2010, 20, 3508-3514.
- [32] Hou C., Huang T., Wang H., Yu H., Zhang Q., et al, A strong and stretchable self-healing film with self-activated pressure sensitivity for potential artificial skin applications, *Scientific Reports.*, 2013, 3, 3138.
- [33] Debroy S., Miriyala V.P.K., VijayaSekhar K., Acharyya S.G., Acharyya A., Graphene heals thy cracks, *Computational Material science*, 2015, 109, 84-89.
- [34] Plimpton S., Fast parallel algorithms for short-range molecular dynamics, *J. Comput. Phys.*, 1995, 117, 1-19.
- [35] Stuart S. J., Tutein A. B., & Harrison J. A., A reactive potential for hydrocarbons with inter molecular interactions, *J. Chem. Phys.*, 2000, 112, 6472-6486.
- [36] Tersoff J., New empirical approach for the structure and energy of covalent systems, *Phys. Rev. B*, 1988, 37, 6991.
- [37] Brenner D. W., Empirical potential for hydrocarbons for use in simulating the chemical vapor deposition of diamond films, *Phys. Rev. B*, 1992, 46, 1948.
- [38] Nose S. A., A unified formulation of the constant temperature molecular dynamics methods, *J. Chem. Phys.*, 1984, 81, 511-519.
- [39] Zhang C. L., and Shen H. S., Self-healing in defective carbon nanotubes: a molecular dynamics study, *J. Phys. Condens. Matter*, 2007, 19, 386212.
- [40] Nardelli M. B., Yakobson B. I., Bernholc J., Mechanism of strain release in carbon nanotubes, *Phys. Rev. B*, 1998, 57, R4277.
- [41] Nardelli M. B., Yakobson B. I., and Bernholc J., Brittle and ductile behavior in carbon nanotubes, *Phys. Rev.Lett*, 1998, 81, 4656.
- [42] Zhang C. L., and Shen H. S., Self-healing in defective carbon nanotubes: a molecular dynamics study, *J. Phys.: Condens. Matter*, 2007, 19, 386212.
- [43] Terrones M., Terrones H., Banhar F., Charlier J. C., Ajayans P. M., Coalescence of single-walled carbon nanotubes, *Science*, 2000, 288 no. 5469, 1226.
- [44] Abell G. C., Empirical chemical pseudopotential theory of molecular and metallic bonding, *Phys. Rev. B*, 1985, 31, 6184.
- [45] Brenner D. W., Shenderova O. A., Harrison J. A., Stuart S. J., Ni B., Sinnott S. B., A second generation reactive empirical bond order (REBO) potential energy expression for hydrocarbons, *J. Phys Condens Matter*, 2002, 14, 783–802.
- [46] Fu X. W., Liao Z. M., Zhou J. X., Zhou Y. B., Wu H. C., et al., Strain dependent resistance in chemical vapor deposition grown graphene, *Appl. Phys. Lett.*, 2011, 99, 213107.
- [47] Jing Z., Guang-Yu Z., and Dong-Xia S., Review of graphene-based strain sensors, *Chin. Phys. B*, 2013, 22, No. 5, 057701.
- [48] Someya T., Sekitan T., Iba S., Kato Y., Kawaguchi H., Sakurai T., A large-area, flexible pressure sensor matrix with organic field effect transistors for artificial skin applications, *Proc. Natl. Acad. Sci.*, 2004, 101, 9966–9970.
- [49] Yannas I. V., Burke J. F., Design of and artificial skin. I. Basic design principles, *J. Biomed. Mater. Res.*, 1980, 14, 65–81.
- [50] Maheshwari V., Saraf R. F., Tactile devices to sense touch on a par with a humanfinger, *Angew. Chem. Int. Ed.*, 2008, 47, 7808–7826.