

## An optimal voltage stability enhancement by locating FACTS in optimal place

P. Rajalakshmi, M. Rathinakumar

Department of Electrical and Electronics Engineering,  
Sri Chandrasekharendra Saraswathi Viswa Mahavidyalaya, India

---

### Article Info

#### Article history:

Received Nov 01, 2018

Revised Jan 11, 2019

Accepted Feb 8, 2019

---

#### Keywords:

Contingent situations  
Optimal solution and Device  
deployment  
Power system  
Voltage stability

---

### ABSTRACT

The electrical components of a power system network take advantage to supply, transmission and service electrical power. Abnormal flow of voltage through the transmission lines might lead to big causes. Thyristor controlled series compensator (TCSC) devices are most frequently used device in the power to maintain the voltage stability. However, this device is costlier and cannot be fixed on every transmission line which would lead to more processing cost. Thus, the maintaining voltage stability of transmission lines with reduced production cost attracts a various researcher to find the novel approaches. In the existing system, to improve the stability of power system and minimize the losses by include the reactive power through TCSC device at applicable location by the algorithm of particle swarm optimization is available with the help of line stability index value. The PSO is constrained to poor exploitation problem which might generate inaccurate results. In the proposed research work, Biogeography Based Krill Herd (BBKH) method is used for optimal identification of TCSC's, STATCOM and UPFC size and location. Voltage collapse proximity indicator (VCPI) value is used in this work for the finding of the voltage instability measurement by finding the critical lines among the entire transmission lines. The proposed research effort is implemented in IEEE 39 test bus system using MATLAB software and verified, it furnishes improved outcome than other investigation methodologies.

Copyright © 2019 Institute of Advanced Engineering and Science.  
All rights reserved.

---

### Corresponding Author:

P. Rajalakshmi,  
Department of Electrical and Electronics Engineering,  
Sri Chandrasekharendra Saraswathi Viswa Mahavidyalaya,  
Tamilnadu, India.  
Email: rajalakshmiee18@outlook.com

---

## 1. INTRODUCTION

In the modern power system network, power system is operating nearby to the limit of stability. So it is necessary to monitor and control the stability and security of power system network. The method should be a rapid analyzing the instability and also to be known to the operator which action to be taken to avoid the voltage collapse. Voltage instability occurs majorly due to inadequacy of the power system accommodated the expanding need of the reactive power [1].

In this research work novel approach is introduced which focus on controlling the voltage stability which occurs due to various contingent effects. By controlling the voltage stability, homes and industries can be supplied with their voltage. This is done by using the TCSC devices by fixing it across the transmission lines in which more fluctuation is happening. In order to reduce the computation and processing cost, TCSC is employed in the only particular location where it is required to control the voltage flow. The critical lines where it is required to fix the TCSC is found by measuring the VCPI line index value and the optimized location and size of TCSC is found using BBKH algorithm based on the critical situation.

The overall analysis of the work is shown below: The first part is general introduction about the power system and the need of voltage stability maintenance is given. In second part, various related research work which has been conducted in terms of maintenance of voltage stability is shown. In third part, precise analysis about the suggested method and terms and notations are interpreted. In the fourth part, outcome of suggested method evaluation is given in detailed. In final part, overall research of the work is concluded.

## 2. RELATED WORKS

Detailed explanation of voltage stability, stimulation for voltage instability, issues of voltage instability and voltage stability enhancement in the power system was presented in the research report (2001, 2003) of power system engineering corporation (PSERC). Power system voltage stability studies, its types, importance of stability and serious problem because of voltage collapse are analyzed in [2], [3]. In [4] proposed a L index method used for identifying voltage instability for the online assessment. When the indicator L value varies from zero (no load) and 1 (voltage collapse) can easily identify the stability margin.

In [5] marginally remodel transient stability program was developed to move toward the complication of voltage collapse. In [6] progressive aspect of voltage collapse and equation in dynamic expressed the activity of voltage collapse provoke by a small change in load are formulated. In [7] furnish outline of online monitoring the security of the power system network. In [8] a rapid static voltage stability index was given. Using this method, power flow jacobian matrix minimum singular value was determined which is used as an indication to identify the instability condition.

In [9] illustration how to reduce voltage collapse risk in the power system by reactive power dispatch algorithm and also different method of power flow are discussed. Using the Newton Raphson Optimal power flow, critical bus or area can be distinguishing from the stable area are suggested in [10]. To improve stable margin by placing the SVC device in optimal location are discussed in [11]. In [12] different FACTS devices performance is compared depend on the voltage range and losses on the nether side of normal and loading condition.

## 3. OPTIMAL MAINTENANCE OF VOLTAGE STABILITY OF POWER SYSTEM USING TCSC DEVICES

Among the FACTS device controller family [12], Thyristor controlled series compensator used to raise line power and enlarge stability margin. In our research work, voltage instability problem which arises due to varying contingency situation is considered to improve the power system performance. At the time of high voltage instability, TCSC devices will be embedded into the transmission lines in which high voltage instability is found in order to stabilize them. So that home and industries can be supplied with their required voltage without any damage to internal circuits. The optimal location (which transmission line) and size (how many TCSC devices based on a number of highly critical transmission lines) are found by using the Biogeography Based Krill Herd algorithm which can resolve poor exploitation problem and lead to high convergence solution. The flow diagram for the proposed work is indicated in Figure 1.

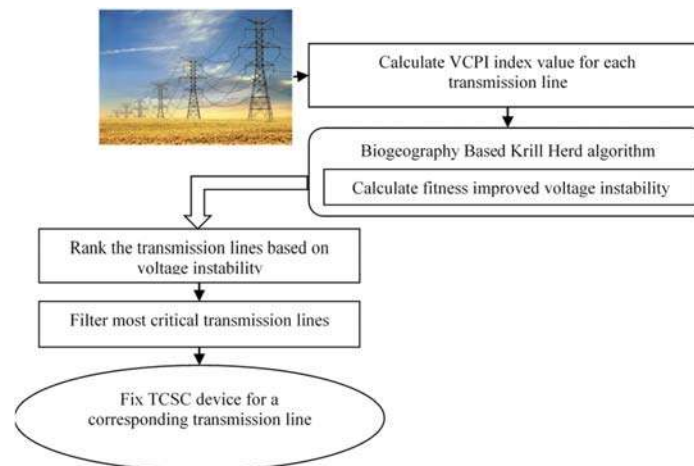

Figure 1. Overall flow of proposed research method

### 3.1. Voltage Collapse Proximity Indicator (VCPI)

Moghavvemi and Faruque [13] suggested Voltage Collapse Proximity Indicator (VCPI) which explained its efficiency and sharpness on the IEEE standard test system at different load condition. This index value will give the information about critical line when the load changes correspondingly. From the Figure 2, VCPI index is derived from the approach of maximum power transmission over the lines and it is given as (1).

$$\text{VCPI (power)} = \frac{P_r}{P_{r(\max)}} = \frac{Q_r}{Q_{r(\max)}} \quad (1)$$

The maximum real and reactive power can be calculated from the (2) and (3).

$$P_{r(\max)} = \frac{V_s^2}{Z_s} \frac{\cos \theta}{4 \cos^2 \left( \frac{\theta - \phi}{2} \right)} \quad (2)$$

$$Q_{r(\max)} = \frac{V_s^2}{Z_s} \frac{\sin \theta}{4 \cos^2 \left( (\theta - \phi)/2 \right)} \quad (3)$$

$V_s$  – Voltage at sending end,  $Z_s$  – line impedance,  $\theta$  – line impedance angle

When there is a variation of power with respect to the voltage variation, this included in VCPI calculation, but in L index method is not deal with it [13]. When the load increases corresponding VCPI value will be from zero (no load) to one (voltage collapse). The line which having the highest VCPI value will be the critical line. This method is adjustable and readily can apply online process. VCPI is a uncomplicated and rapid method to workout compared with other static L index method [10].

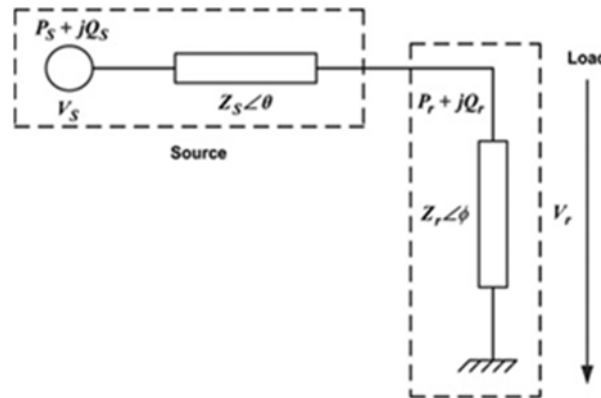

Figure 2. VCPI index

### 3.2. Biogeography Based Krill Herd

It has been proved that KH is an effective method of exploitation. However, because the search relies fully on randomness, it cannot converge rapidly. In the group strategy optimization algorithm, the number of iterations could affect the performance of the algorithm, and sometimes even determines whether we can find the global optimal point. We should also consider the factor of time (the optimization process should be as quick as possible), so we present a novel way of computing the decision weighting factor to give KH better global searching ability performance and a higher convergence speed. Its equation is shown in (4).

$$\frac{dx_i}{dt} = \frac{MI-I}{MI} F_i + \frac{1}{MI} N_i + D_i \quad (4)$$

where  $MI$  is the maximum iteration, and  $I$  is the current number of iterations. At the early stage of iterations,  $(MI - I)/MI > I/MI$ , their foraging actions should have more influence on their decisions for the next position. Because each krill doesn't know the correct direction, that krill start with their own feelings can effectively help them avoid prematurely. At the later stage of iterations,  $(MI - I)/MI < I/MI$ , the experience of other krill has more influence when they update their next position.

After all, the correctness of the group direction tends to be higher than that of the individuals. Finally, we define the KH with an updated crossover operator as the standard krill swarm algorithm. The method we proposed as the Biogeography Based Krill Herd (BBKH). The basic framework of the BBKH method and its responding flowchart are shown in Algorithm 1.

*Algorithm 1: BBKH algorithm*

**Begin**

**Step 1: Initialization.** Initialize the Iteration counter  $I=1$ , the population  $P$  of NP krill,  $V_i$ ,  $D^{\max}$  and  $N^{\max}$

**Step 2: Fitness calculation.** Calculate fitness for each krill according to its initial position

**Step 3: While**  $I < \text{Maximum Iteration}$  **do**

Sort all the population according to their fitness

**for**  $i=1:N_P$  (all krill) **do**

Perform the following motion calculation

Motion induced by other individuals

Foraging motion

Physical diffusion

Compute  $dx_i/dt$  according to (8)

Implement the crossover operator

Updating the krill individual position in the search space

Calculate fitness for each krill according to its new position

**end for**  $i$

$I = I + 1$

**Step 4: end while**

**End.**

In the above algorithm, fitness is taken as voltage stability improvement. Maintaining the acceptable voltage stability level under normal, stressed and contingency operating conditions is an important concern in power system planning and operation. For this aim, the minimization of the total VSI (VCPIT) and total losses is proposed as an objective function to enhance the overall voltage stability of the system. The VCPIT is the sum of the voltage stability indices for all the lines of the system and it is mathematically evaluated as

$$VCPI_T = \sum_{i=1}^{N_l} VCPI_i \quad (5)$$

Where  $VCPI_i$  is the VCPI for line  $i$  and  $N_l$  is the number of transmission lines in the system.

### 3.2.1. Objective Function

The main objective function is to minimize VCPI and losses. It can be representing as

$$F_o(x) = \min(VCPI) + \min(Loss) \quad (6)$$

Where VCPI is voltage collapse proximity index for the loads represent in IEEE 39 bus, losses indicate total losses in IEEE 39 bus. The minimization problem is subject to the following equality and inequality constraints:

1) Power flow constraints:

$$P_k - V_k \sum_{L=1}^{N_g} V_L (G_{KL} \cos \theta_{kL} + B_{KL} \sin \theta_{kL}) = 0 \quad k = 1, 2 \dots N - 1$$

$$Q_k - V_k \sum_{L=1}^{N_g} V_L (G_{KL} \sin \theta_{kL} - B_{KL} \cos \theta_{kL}) = 0 \quad k = 1, 2 \dots N_L$$

2) Voltage range

$$V_k^{\min} \leq V_K \leq V_K^{\max} \quad K \in N$$

3) Generator reactive power capability range

$$Q_{gk}^{\min} \leq Q_{gK} \leq Q_{gK}^{\max} \quad K \in N_g$$

4) Reactive power generation limit of capacitor bank

$$Q_{ck}^{min} \leq Q_{ck} \leq Q_{ck}^{max} \quad K \in N_c$$

5) Voltage stability range

$$VCPI_l^{max} \leq VCPI_l^{min}$$

6) Transmission line flow limit

$$S_l^{min} \leq S_l^{max} \quad l \in N_l$$

In this proposed work control variables are voltage in generator bus, reactive power generated from capacitor bank and active power, they are self-restricted. State variables are voltage in load bus, reactive power generator and line flow, these limits are satisfied by adding a penalty terms in objective function.

#### 4. RESULTS AND DISCUSSION

The proposed research methodology is conducted in IEEE 39 bus test system in MATLAB simulation environment. This IEEE 39 bus have ten generator buses, thirty load buses and 46 lines [14]. The proposed research scenario is compared with the existing research work namely Particle Swarm Optimization (PSO) to prove the performance improvement. This comparison evaluation is done against various performance metrics, for example,

- Cost** – Total cost consumed for setting up overall device configuration and the processing cost consumed.
- Voltage collapse proximity indicator** – This method is depending on reactivity of the load variation in any particular bus is indicated by varying the reactive demand. For each line, VCPI value is based on maximum power transferred.
- Voltage level** – it is referring as maintain the voltage level after it subject to disturbance. If the demand increases continuous it enters voltage instability region due to this there will be drop in voltage level.

These measures are evaluated under varying load conditions and timing for both proposed and existing research methodologies.

In the experimental research scenario, three power controllers are used for the evaluation of the proposed method performance in terms optimal decision making of size and location of devices. The power controllers used in this work for the evaluation of the proposed research method is

- Thyristor-controlled series capacitors (TCSC).
- Static synchronous compensator (STATCOM).
- Unified power flow controller (UPFC).

The correlative assessment among the proposed method BBKH and the current method PSO under three power controllers namely TCSC, STATCOM and UPFC are illustrated in the following subsection. The parameter setting values of PSO and BBKH algorithms is shown below Table 1.

The proposed method is to vary load condition [100%, 110%, 120%] corresponding VCPI is evaluated. From the maximum VCPI value three critical lines are identified (.9183 in 23-36, 0.9113 in 16-19 and 0.9168 in 6-31 lines). With these simulation setting values, the algorithms are evaluated to measure the optimal VCPI index values. This simulation is carried out in these three critical lines.

From this simulation outcome in Table 2, it can be proved that the proposed optimization methods BBKH can yields better performance in terms of reduced VCPI index value. In all these output case 1 from the VCPI index weak line is 6-31 then using optimization techniques we find the optimal location is 6-7 we conclude VCPI value and losses are reduced. In full load level (100%), BBKH achieves 2.68% reduced VCPI index level than PSO and 14.25% reduced VCPI index level than No FACTS. Likewise, BBKH yields reduced VCPI index level at all load levels. And also, it is confirmed that the BBKH can find its location between the slight variation such as in this case the optimal location is between 6-7. BBKH yields less power loss than the other techniques.

From this simulation outcome in Table 3, it can be proved that the proposed optimization methods BBKH can yields better performance in terms of reduced VCPI index value. In all these output case 2 from the VCPI index weak line is 16-19 then using optimization techniques we find the optimal location is 16-19 which is similar in both cases. In full load level (100%), BBKH achieves 5.18% reduced VCPI index level than PSO

and 13.17% reduced VCPI index level than No FACTS. Likewise, BBKH yields reduced VCPI index level at all load levels. And also, it is confirmed that the BBKH can find its location similar in all cases such as the optimal location is between buses 16-19. BBKH yields less power loss than the other techniques.

From this simulation outcome in Table 4, it can be proved that the proposed optimization methods BBKH can yields better performance in terms of reduced VCPI index value. In all these output case 1 from the VCPI index weal line is 23-36 then using optimization techniques we find the optimal location is 23-22 we conclude VCPI value and losses are reduced. In full load level (100%), BBKH achieves 2.67% increased VCPI index level than PSO and 7.3% reduced VCPI index level than No FACTS.

Likewise, BBKH yields reduced VCPI index level at all load levels. And also, it is confirmed that the BBKH can find its location similar in all cases such as in this case the optimal location is between 23-22. BBKH yields less power loss than the other techniques.

Table 1. Simulation parameter setting values of PSO and BBKH

PSO Parameters		BBKH Parameters	
Parameter	Value	Parameter	Value
Population size	20	Population size	40
C1	1.5	Wf (Foraging)	0.3
C2	2.5	Wn (inertia movement)	0.3
Inertia	0.3	Dmin (Diffusion)	0.005
Damp ratio	0.95	Dmax	0.01
Iterations	60	Iterations	50

Table 2. Case 1 Simulation outcome

Loading	Algorithm	VCPI	Location	UPFC	STATCOM	TCSC	Real Power Loss (MW)
				Size voltage angle	Size MVar	Size MVar	
100%	No FACTS	0.8536		--			65.3
	PSO	0.7521	6-7	0.9842	6.58	5.96	54.4
	BBKH	0.7319	6-7	1.1221	6.94	6.32	57.5
110%	No FACTS	0.8991		--			69.9
	PSO	0.6975	6-7	1.0245	5.67	5.01	47.3
	BBKH	0.6833	6-7	1.4843	5.34	5.39	48.8
120%	No FACTS	0.9168		--			72.5
	PSO	0.6572	6-7	0.8436	5.88	5.43	52.6
	BBKH	0.6530	6-7	0.9751	5.72	5.19	49.6

Table 3. Case 2 Simulation outcome

Loading	Algorithm	VCPI	Location	UPFC	STATCOM	TCSC	Real Power Loss (MW)
				Size voltage angle	Size MVar	Size MVar	
100%	No FACTS	0.8653		--			93.4
	PSO	0.7924	16-19	56.8	5.29	5.21	56.8
	BBKH	0.7513	16-19	47.6	6.32	6.89	47.6
110%	No FACTS	0.8665		--			87.5
	PSO	0.7058	16-19	57.1	5.67	5.12	57.1
	BBKH	0.6861	16-19	58.3	5.49	5.30	58.3
120%	No FACTS	0.9113		--			72.9
	PSO	0.7125	16-19	50.2	5.64	5.90	50.2
	BBKH	0.6827	16-19	51.7	5.29	5.10	51.7

Table 4. Case 3 Simulation outcome

Loading	Algorithm	VCPI	Location	UPFC	STATCOM	TCSC	Real Power Loss (MW)
				Size voltage angle	Size MVar	Size MVar	
100%	No FACTS	0.7252		--			55.2
	PSO	0.6547	23-22	57.61	6.27	5.68	57.61
	BBKH	0.6722	23-22	60.71	6.94	6.04	60.71
110%	No FACTS	0.8735		--			68.2
	PSO	0.7014	23-22	50.51	5.67	4.73	50.51
	BBKH	0.6489	23-22	52.01	5.34	5.11	52.01
120%	No FACTS	0.9183		--			64.8
	PSO	0.7170	23-22	55.81	5.88	5.15	55.81
	BBKH	0.6571	23-22	52.81	5.72	4.91	52.81

#### 4.1. TCSC Devices

TCSC devices are most costly which needs to be allocated optimally with the goal of reduced cost and improved power transmission capability. TCSC is devices which introduce capacitor in series along the transmission line and controlled the inductor connect parallel with capacitor. Due to its adjustable control of thyristors, it is more capable and produces reasonable [15]. In the operation and control of power system TCSC play important role such as

- Enhancing power flow
- Limiting fault
- Enhancing transient
- Dynamic stability

The comparison of proposed and existing research method in the problem space optimal decision taking about location and size of TCSC devices under three different performance metrics is shown and explained in the following figures. The proposed research work should select the optimal combination of TCSC devices so the maximum power transmission capacity can be achieved with the reduced cost level. The cost consumed for the optimal combination of TCSC devices are illustrated in the following Figure 3.

In the above Figure 3, cost consumption value of the proposed methodology BBKH is illustrated. The optimal TCSC device combination with reduced cost level is obtained in its 20<sup>th</sup> iteration of the BBKH algorithm itself which is present stable in increased iteration levels. In the Figure 3, it is justify such that put forward research approach BBKH shows a slight improvement in terms of reduced cost than the existing research method PSO. The BBKH attains 1.6% performance improvement than the existing method PSO.

VCPI level of different lines after deciding the optimal allocation of TCSC devices are illustrated in the following Figure 4.

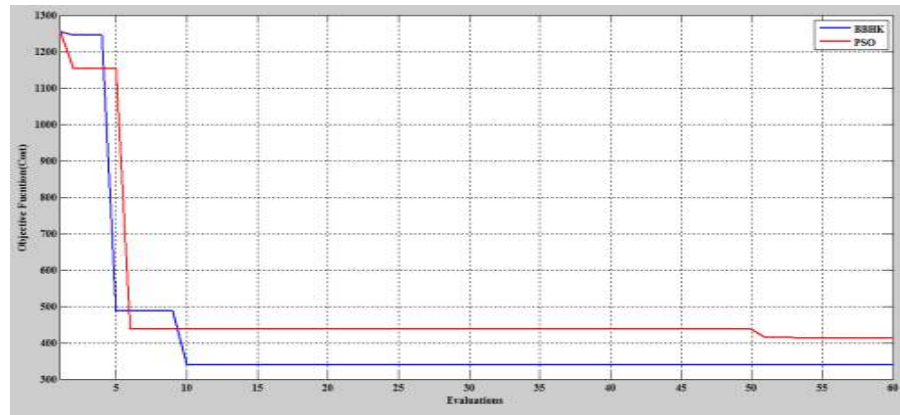

Figure 3. Cost of allocating optimal allocated of TCSC devices

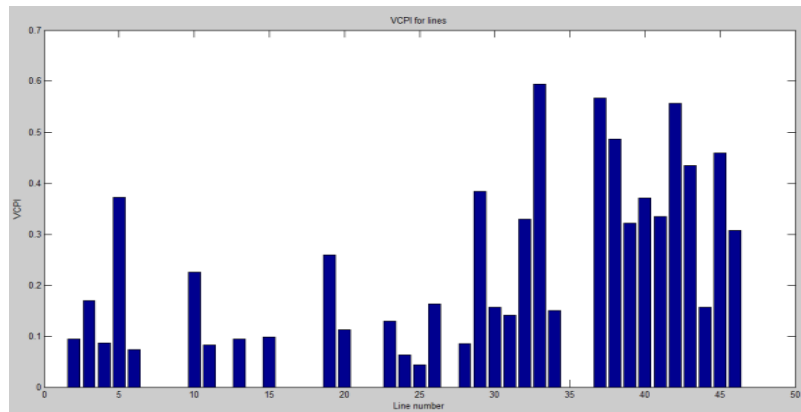

Figure 4. VCPI index level

In the above Figure 4, performance assessment of the proposed is shown with regard to VCPI index level. The line with VCPI index value closer to the unit or higher unit values is called weak lines. Thus it is required to allocate with more TCSC devices for reaching better voltage stability. From this figure, it can confirm that after allocating TCSC devices using BBKH algorithm, the number of weak buses are reduced in number. It shows 40% performance improvement than the existing method PSO. The results clearly show a considerable reduction of the variable values with the addition of the VCPI index as the voltage stability constraint. The real power loss (Ploss) and the reactive power generation (Qgen) are reduced by 8.525 MW and 27.62 MVAR, respectively, corresponding to the 47.25 and 17.07% reduction. For the line outage contingency case, it is obvious that both the voltage stability improvement and the real power loss minimization are satisfied when adding the voltage stability constraint, with 47.25% reduction in the real power loss and 32.54% reduction in the VSI.

However, this case has caused an increase in the fuel cost by 10.03%. In the following Figure 5, voltage level measured in the different buses is compared to the proposed and existing scenario.

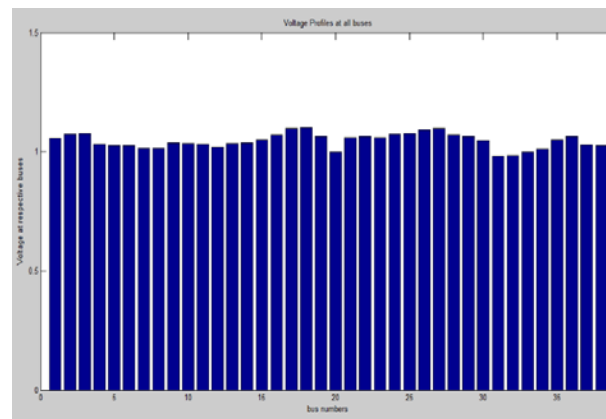

Figure 5. Voltage level comparison

In the above Figure 5, performance evaluation of the proposed method in terms of the voltage level in different buses is given. From this given figure it can be proved that the proposed research scenario leads to provide a better result than the existing researchers. The voltage stability of the proposed research BBKH is better than the existing works by maintaining voltage flow rate through different buses in the near to similar rate where the existing research methods cannot stabilize voltage supply rate. It shows 32% performance improvement than the existing method PSO.

#### 4.2. STATCOM Devices

A static synchronous compensator (STATCOM), also known as a static synchronous condenser (STATCON), is a regulating device used on alternating current electricity transmission networks. It is based on a power electronics voltage-source converter and can act as either a source or sink of reactive AC power to an electricity network. If connected to a source of power it can also provide active AC power. It is a member of the FACTS family of devices. It is inherently modular and electable. Usually, a STATCOM is installed to support electricity networks that have a poor power factor and often poor voltage regulation. There are however, other uses, the most common use is for voltage stability. A STATCOM is a voltage source converter (VSC)-based device, with the voltage source behind a reactor [16]. The voltage source is created from a DC capacitor and therefore a STATCOM has very little active power capability. However, its active power capability can be increased if a suitable energy storage device is connected to the DC capacitor. The reactive power at the terminals of the STATCOM depends on the amplitude of the voltage source. For example, if the terminal voltage of the VSC is higher than the AC voltage at the point of connection, the STATCOM generates reactive current; conversely, when the amplitude of the voltage source is lower than the AC voltage, it absorbs reactive power. The response time of a STATCOM is shorter than that of a static VAR compensator (SVC), mainly due to the fast switching times provided by the IGBTs of the voltage source converter. The STATCOM also provides better reactive power support at low AC voltages than an SVC, since the reactive power from a STATCOM decreases linearly with the AC voltage (as the current can be maintained at the rated value even down to low AC voltage).



A comparative evaluation of the proposed and existing methods in the STATCOM controller devices under performance metrics is evaluated and discussed below. The comparison of proposed and existing research method in the problem space optimal decision taking about location and size of STATCOM devices under three different performance metrics is shown and explained in the following figures. The proposed research work should select the optimal combination of STATCOM devices so the maximum power transmission capacity can be achieved with the reduced cost level. The cost consumed for the optimal combination of STATCOM devices are illustrated in the following Figure 6.

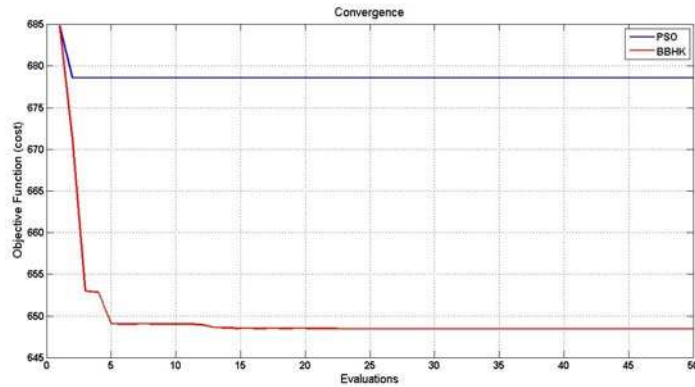

Figure 6. Cost of allocating optimal allocated of STATCOM devices

In the above Figure 6, cost consumption value of the proposed methodology BBKH is illustrated. The optimal STATCOM device combination with reduced cost level is obtained in its 20<sup>th</sup> iteration of the BBKH algorithm itself which is present stable in increased iteration levels. In the Figure 3, it is justify such that put forward research approach BBKH shows a slight improvement in terms of reduced cost than the existing research method PSO. The BBKH attains 0.68% performance improvement than the existing method PSO.

VCPI level of different buses after deciding the optimal allocation of STATCOM devices are illustrated in the following Figure 5.

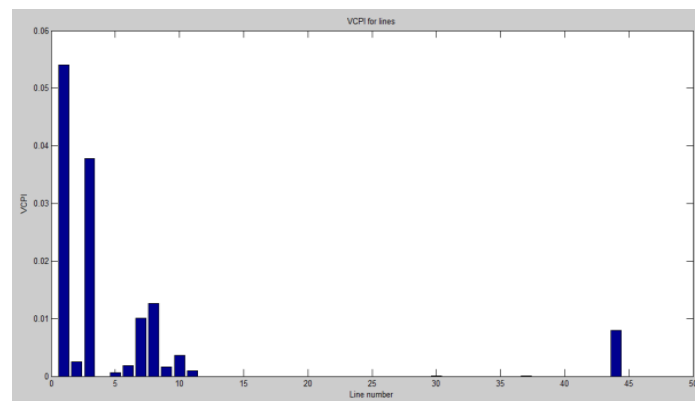

Figure 7. VCPI index level

In the above Figure 7, assessment of the proposed is shown with regard to VCPI index level. The line with VCPI index value closer to the unit or higher unit values is called weak line. Thus it is required to allocate with more STATCOM devices for reaching better voltage stability. From this figure, it can confirm that after allocating STATCOM devices using BBKH algorithm, the number of weak buses is reduced in number. It shows 37% performance improvement than the existing method PSO. In the following Figure 8, voltage level measured in the different buses is compared to the proposed and existing scenario.

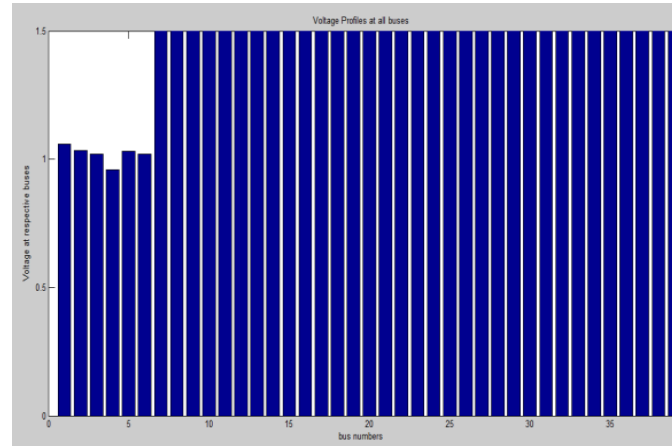

Figure 8. Voltage level comparison

In the above Figure 8, performance evaluation of the proposed method in terms of the voltage level in different buses is given. From this given figure it can be proved that the proposed research scenario leads to provide a better result than the existing researchers. The voltage stability of the proposed research BBKH is better than the existing works by maintaining voltage flow rate through different buses in the near to similar rate where the existing research methods cannot stabilize voltage supply rate. It shows 3% performance improvement than the existing method PSO.

#### 4.3. UPFC Devices

A unified power flow controller (or UPFC) is an electrical device for providing fast-acting reactive power compensation on high-voltage electricity transmission networks. It uses a pair of three-phase controllable bridges to produce the current that is injected into a transmission line using a series transformer. The controller can control active and reactive power flows in a transmission line. The UPFC uses solid state devices, which provide functional flexibility, generally not attainable by conventional thyristor-controlled systems. The UPFC is a combination of a static synchronous compensator (STATCOM) and a static synchronous series compensator (SSSC) coupled via a common DC voltage link [17].

The main advantage of the UPFC is to control the active and reactive power flows in the transmission line. If there are any disturbances or faults in the source side, the UPFC will not work. The UPFC operates only under balanced sine wave source. The controllable parameters of the UPFC are reactance in the line, phase angle, and voltage. The UPFC concept was described in 1995 by L. Gyugyi of Westinghouse. The UPFC allows a secondary but important function such as stability control to suppress power system oscillations improving the transient stability of power system. A comparative evaluation of the proposed and existing methods in the UPFC devices under performance metrics is evaluated and discussed below. The comparison of proposed and existing research method in the problem space optimal decision taking about location and size of UPFC devices under three different performance metrics is shown and explained in the following figures. The proposed research work should select the optimal combination of UPFC devices so the maximum power transmission capacity can be achieved with the reduced cost level. The cost consumed for the optimal combination of UPFC devices are illustrated in the following Figure 9.

In the above Figure 9, cost consumption value of the proposed methodology BBKH is illustrated. The optimal UPFC device combination with reduced cost level is obtained in its 20<sup>th</sup> iteration of the BBKH algorithm itself which is present stable in increased iteration levels. In the Figure 3, it is justify such that put forward research approach BBKH shows a slight improvement in terms of reduced cost than the existing research method PSO. The BBKH attains 0.68% performance improvement than the existing method PSO.

VCPI level of different buses after deciding the optimal allocation of UPFC devices are illustrated in the following Figure 10.

In the above Figure 10, performance assessment of the proposed is shown with regard to VCPI index level. The line with VCPI index value closer to the unit or higher unit values is called weak line. Thus it is required to allocate with more UPFC devices for reaching better voltage stability. From this figure, it can confirm that after allocating UPFC devices using BBKH algorithm, the number of weak buses are reduced in number. It shows 37% performance improvement than the existing method PSO.

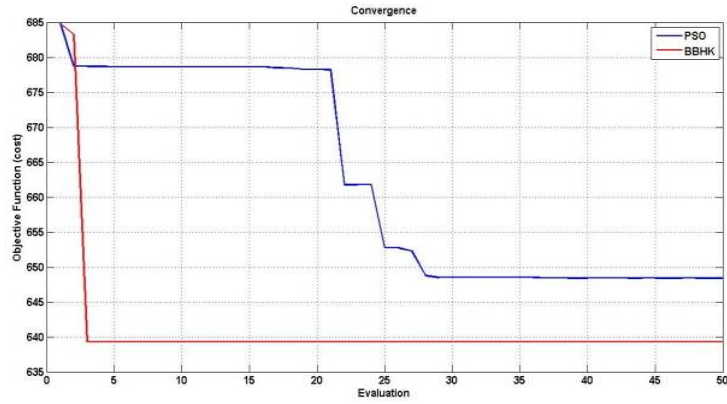

Figure 9. Cost of allocating optimal allocated of UPFC devices

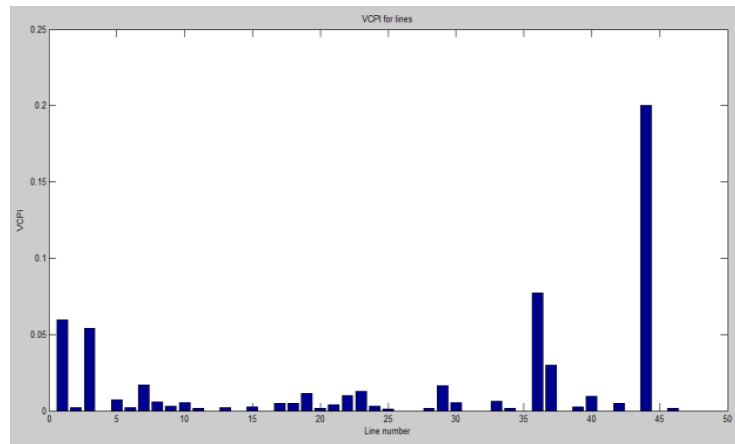

Figure 10. VCPI index level

In the following Figure 11, voltage level measured in the different buses is compared to the proposed and existing scenario.

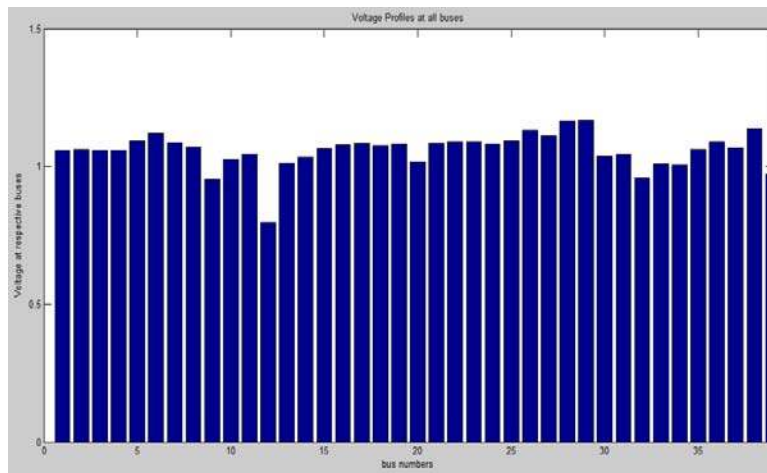

Figure 11. Voltage level comparison

In the above Figure 11, performance evaluation of the proposed method in terms of the voltage level in different buses is given. From this given figure it can be proved that the proposed research scenario leads to provide a better result than the existing researchers. The voltage stability of the proposed research BBKH is better than the existing works by maintaining voltage flow rate through different buses in the near to similar rate where the existing research methods cannot stabilize voltage supply rate. It shows 3% performance improvement than the existing method PSO.

## 5. CONCLUSION

Voltage stability management plays a most concerned problem in the power system from where electricity distributed to the different places. In this research work, TCSC devices are used for controlling the voltage supply rate. To enhance the cost deficiency optimal location and size of the TCSC devices are found by using the optimization algorithm namely Biogeography Based Krill Herd algorithm. This algorithm will find the most optimal locations to fix the TCSC devices based on the critical level of transmission lines. The critical power transmission lines are found by measuring the VCPI index value which will find the most critical transmission lines with more voltage deviation. Based VCPI value optimal location and size of TCSC devices are found. The experimental tests were conducted in the Matlab simulation environment from which it is proved that the proposed research scenario leads to provide a better result than the existing methods. The performance evaluation was conducted for the three power controller devices namely TCSC, STATCOM, and UPFC. The performance results from these three controllers prove that the proposed method BBKH performs better and provide improved result in all kind of environment setup and configuration than the existing method PSO.

## REFERENCES

- [1] Musirin I., Rahman T.A., "Novel fast voltage stability index (FVSI) for voltage stability analysis in power transmission system," *IEEE Student Conference on Research and Development*, pp. 265-268, 2002.
- [2] Kundur P., Paserba J., Ajarapu V., Andersson G., Bose A., Canizares C., & Van Cutsem T., "Definition and classification of power system stability IEEE/CIGRE joint task force on stability terms and definitions," *IEEE Transactions on Power Systems*, vol. 19(3), pp. 1387-1401, 2004.
- [3] Van Cutsem T., & Vourmas C.D., "Emergency voltage stability controls: an overview. *IEEE Power Engineering Society General Meeting*, pp. 1-10, 2007.
- [4] Kessel P.; & Glavitsch H., "Estimating the voltage stability of a power system," *IEEE Transactions on Power Delivery*, vol. 1(3), pp. 346-354, 1986.
- [5] Begovic M.M., & Phadke A.G., "Voltage stability assessment through measurement of a reduced state vector," *IEEE transactions on power systems*, vol. 5(1), pp. 198-203, 1990.
- [6] McLennan M.J., Lee Y., & Datta S. "Voltage drop in mesoscopic systems: A numerical study using a quantum kinetic equation," *Physical Review B*, vol. 43(17), pp. 13846, 1991.
- [7] Balu N., Bertram T., Bose A., Brandwajn V., Cauley G., Curtice D., and Wrubel J.N., "On-line power system security analysis," *Proceedings of the IEEE*, pp. 262-282, 1992.
- [8] Lof P.A., Smed T., Andersson G., & Hill D.J. "Fast calculation of a voltage stability index," *IEEE Transactions on Power Systems*, vol. 7(1), pp. 54-64, 1992.
- [9] Chebbo A.M., Irving M.R., and Sterling M.J.H., "Voltage collapse proximity indicator: behavior and implications," in *IEE Proceedings C-Generation, Transmission and Distribution*, pp. 241-252, 1992.
- [10] Hong Y.Y., and Gau C.H., "Voltage stability indicator for identification of the weakest bus/area in power systems," *IEE Proceedings-Generation, Transmission and Distribution*, vol. 141(4), pp. 305-309, 1994.
- [11] Mínguez R., Milano F., Zárate-Miñano R., & Conejo A.J., "Optimal network placement of SVC devices," *IEEE Transactions on Power Systems*, vol. 22(4), pp. 1851-1860, 2007.
- [12] Sode-Yome A., Mithulananthan N., & Lee K.Y., "A comprehensive comparison of FACTS devices for enhancing static voltage stability," in *IEEE Power Engineering Society General Meeting*, pp. 1-8, 2007.
- [13] Moghavvemi M., and Faruque M.O., "Estimation of Voltage Collapse from Local Measurement of Line Power Flow and Bus Voltages," *Proceedings of the International Conference on Electric Power Engineering*, 1999.
- [14] T. Athay, R. Podmore, and S. Virmani, "A Practical Method for the Direct Analysis of Transient Stability," *IEEE Transactions on Power Apparatus and Systems*, vol. 98(2), pp. 573-584, 1979.
- [15] Neha Smitha, Prem prakhas, "Power quality of distribution system by reactive power compensation," *International conference on power and embedded drive control*, *IEEE*, 2017.
- [16] K. Karthikeyan, P. K. Dhal, "Optimal location of STATCOM based dynamic stability analysis tuning of PSS using particle swarm optimization," *science direct, materials today proceedings*, vol. 5, pp. 588-595, 2018.
- [17] J. Nirmal Kumar P.G, G. Muruganandam, "Enhancement of voltage stability using by UPFC," *International Journal of Engineering Development and Research*, vol. 5(2), 2017.